

# APartE

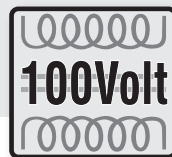

# MANUAL



# MA200

[INFO@APART-AUDIO.COM](mailto:INFO@APART-AUDIO.COM)

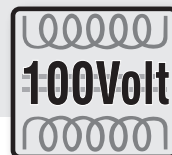

## Safety First!

- Read all documentation before operating your equipment.
- Retain all documentation for future reference.
- Save the carton and packing material even if the equipment has arrived in good condition. Should you ever need to ship the unit, use only the original factory packing.
- Do not spill water or other liquids into or on the unit.
- Make sure power outlets conform to the power requirements listed on the back of the unit.
- Do not use the unit if the electrical power cord is frayed or broken.
- Always operate the unit with the AC ground wire connected to the electrical system ground.
- Have gain controls on amplifiers turned down during power-up to prevent speaker damage if there are high signal levels at the inputs.
- Do not connect the inputs / outputs of amplifiers or consoles to any other voltage source, such as a battery, mains source, or power supply, regardless of whether the amplifier or console is turned on or off.
- Power down & disconnect units from mains voltage before making connections.
- Do not use the unit near stoves, heat registers, radiators, or other heat producing devices.
- Do not block fan intake or exhaust ports. Do not operate equipment on a surface or in an environment which may distort the normal flow of air around the unit. If the unit is used in an Extremely dusty or smoky environment, the unit should be periodically "blown free" of dust.
- Do not remove the cover. Removing the cover will expose you to potentially dangerous voltages.
- Do not drive the inputs with a signal level greater than that required to drive equipment to full output.
- Do not run the output of any amplifier back into another input.
- Do not ground the red output terminal, never connect a red output terminal to another red output terminal.
- In case of mal-function this device should be serviced by qualified service personnel only.



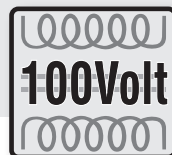

- 1. APart MA200 Mixing Amplifier*
- 2. Front Panel*
- 3. Rear Panel*
- 4. Inside Settings*
- 5. Overview Of The MA200 Series*
- 6. How To Deal With 100V Loudspeakers Systems*
- 7. Technical Specifications*
- 8. Block Diagram*
- 9. Notes*

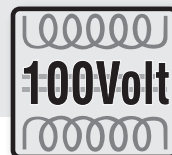

## **1. APart MA200 Mixing Amplifier**

The MA200 is a professional 4 zone PA mixing amplifier for commercial and industrial applications. Rarely seen on its competitors, all microphone inputs have integrated speech filters and they are high-class

transistor-balanced type, allowing good control of hum and noise over long cables.

He's able to drive 8-ohm or constant-voltage loudspeaker lines (50-70-100V).

The amplifier has integrated radio, 4 microphone inputs, 4 selectable line sources and one emergency/telephone input.

Mic input 1 is meant to be the main microphone paging input, for its signal can be fed via the front ¼" TRS phone jack or via a combo XLR3/jack, DIN 5 or euroblock connector at the back.

The MA200 has a three level priority system.

The emergency/telephone input at the back has the highest priority. Its signal goes directly to the main amplifier, bypassing any front control, and an attenuator next to the input sets its level. Microphone input 1 has the second priority level. With the control next to the XLR input, the vox (voice activated) mute for microphone 1 can be activated and mutes all other signals, except the emergency input. The third level can be activated via a dry contact ("priority over music") and mutes all background music inputs only. This contact activates the chime as well, only when a level has been set using the "chime level" potentiometer.

4 Zones can be individually switched on and off.

Compared to other zone amplifiers, the total load (200W) can be drawn in any combination from the 4 zones.

Zone 4 has an extra feature. Via the selectors at the front, you can choose whether this zone receives back ground music only, messages only, both or none of them.

When any priority has been activated, 24V DC output (max.1A) will be available to activate priority relays of loudspeaker attenuators or other devices.

When needed, the signals distributed via your MA200 mixing amplifier, can be recorded via the record output.

19" Brackets are shipped along with your amplifier.

The MA200 is the all in one device to built larger professional industrial sound applications. You can insert an extra equalizer (such as the APart PXQ2215) into the signal path or add extra power amps (APart PA240P), using the pre amp out/power amp in RCA connectors. When shipped a RCA bridge has been inserted.

The MA200 complies with the CE standards.

## 2. Front Panel

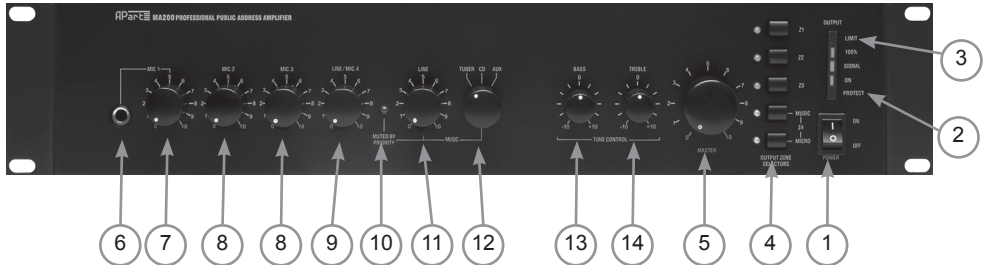

- 1) Power switch: Here you can switch the power on and off.
- 2) Overload indicator: This red LED illuminates when one of the protections have been activated. No or distorted sound will be heard anymore. This will be in case of overheating, being the result of drawing too much power from your amplifier, or the impedance of the speaker lines connected are below the minimum load impedance (see17).
- 3) Level indicators/clip-limit: A green LED will light after powering on. To work within normal conditions the volume indicator should be kept under 0dB (100%). At -2,5dB a limiter will be activated. This red LED indicates that the "auto gain circuit" keeps the level below clipping. This is NOT a clip indicator, but an indication of the "automatic gain control".
- 4) Zone selectors: With these selectors you can activate the zone outputs. A green led at the left of the switches will confirm that you have activated zone 1 to 3. For zone 4, two selectors are available. By means of those two selectors you can decide to send background music only, spoken messages only, both or none of them. Two yellow leds will confirm your selection. When you have selected the music only mode for zone 4, there will be silence during paging.
- 5) Master level control. Here you can adjust the desired volume of the overall signal.
- 6) Microphone 1 input: This balanced ¼" TRS phone jack has been wired in parallel with the other three input options for microphone 1 at the back. For satisfying operation, use only one of these inputs at the time for microphone 1. Microphone 1 can be given a priority over all other inputs by using the VOX priority (see 29).
- 7) Microphone 1 level control: Adjusts the volume of the microphone connected to one of the four input connectors (1/4" jack, XLR3 combo jack, DIN5 or euro block).
- 8) Microphone 2 3 level control: By turning each control clockwise the desired level of that input in the total mix is set. To decrease these levels, turn counter-clockwise. The volumes of the inputs not in use, should be set fully counter-clockwise. If not, hiss might occur.
- 9) Microphone 4 / line 4 level control: Adjusts the input signal of the microphone connected to the XLR combo jack at the back or the line source connected to stereo RCA input 4.
- 10) "Muted by priority" led: This red led will blink when any priority status has been activated.
- 11) Music level control: Here you can adjust the level of the line source selected.
- 12) Line source selector: Select the desired music source to be heard (AUX, CD or TUNER).
- 13) Bass control: Adjust as per your taste. In reverberant rooms intelligibility can be increased by decreasing bass. The centre position gives you a flat response.
- 14) Treble control: Adjust the level as per your taste or needs. Adding high frequencies gives brilliance to your sound. High frequency feedback can be removed by decreasing treble. The centre position gives you a flat response.

## 3. Rear Panel

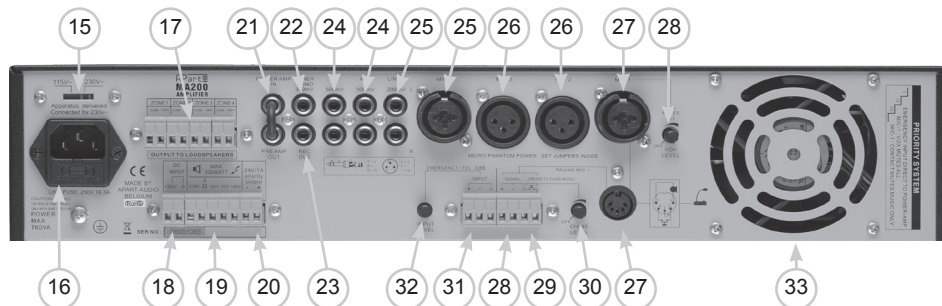

- 15) Voltage selector: Set the local voltage. If any doubt, contact your dealer. The unit is shipped with the selector set to 230VAC.
- 16) Mains socket: The unit can be connected to the mains circuit by a standard IEC type power cord. This socket contains a 6,3AT, slow blow fuse. Use a screw driver to flip out the fuse compartment and to replace it by the same type. When this fuse blows frequently, you should check the speaker load or bring the MA200 to a qualified service centre. First check whether you didn't use a quick-blow fuse!
- 17) Zone 100V loudspeaker outputs: When you need to activate/deactivate separate loudspeaker zones, you should use these 100V outputs. These connectors should only be used for 100V operation. They are activated by the selectors at the front (see 4). Don't use these 100V outputs together with the 8 ohm, 50V or 70V terminals. The minimum impedance of all 100V loudspeaker lines together should be at least 50Ω ( $100V \times 100V / 50 = 200\text{watt}$ ).
- 18) Emergency power supply: You can power the amplifier directly from an emergency battery or power supply supplying 24V DC/20A.
- 19) Loudspeaker outputs: For low impedance use com and 8Ω. Keep impedance above 8Ω. For 50, 70 or 100V speaker lines use COM and 50, 70 or 100V terminals. For 100V operation, the total minimum impedance of the loudspeaker lines should be 50 Ω. For 70V operation the minimum impedance should be 24,5 Ω and for 50V 12,5 Ω. Don't mix the types of speaker connections. Only one at the time should be used, unless you are able to calculate a combination which does not overload the amplifier (example: 100Ω at 100V for a loud zone in combination with 25Ω at 50V for a quiet zone).
- 20) 24V DC output: At this terminal (-/+) 24V DC will be available (max. 1A) from the moment a priority has been activated, to control priority relays of local volume attenuators or other devices.
- 21) Power amp in / pre amp out: You can send the signal of the pre-amplifier to an external device such as an equalizer (APart PXQ2215) or limiter and feed the treated signal back into the amplifier via the power amp input. From the "pre-amplifier out" you can also feed extra power amplifiers such as the Apart PA240P. Don't forget to feed the signal back into the "power amp in". When you don't use this feature, the RCA bridge should be placed.
- 22) Tuner output mono: Here you can recover a fixed signal of the internal tuner to feed other devices such as your telephone's 'music on hold' system.
- 23) Rec. out: When you need a copy of the total mix, you can connect this output to any recording device such as tape deck, MD recorder, VHS recorder, etc....You can also use this output to feed an extra amplifier. This output level cannot be controlled separately. When you connect your MA200 pre amp out or record out to a microphone input of another mixing amplifier, this input will have signal overload and the sound will be masked. In this case you should use a line input, a DI-box or other signal levelling device. Never connect this output to an amplifier loudspeaker output!

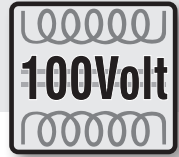

- 24) CD stereo input, 500mV: Use these stereo RCA inputs to connect a line level source such as CD players, MD players, etc.... You have to make your choice with the selector at the front (see 12). Stereo signals will be summed together.
- 25) Line 4, input, 200mV/ Mic 4 input. Use only one of these parallel wired inputs at the time! For line levels see 24. To the XLR3 balanced input you can connect any microphone using a balanced, two wire shielded, cable. (1=earth / 2 =hot / 3=cold). For using condenser microphones see 34. The Microphone 4 input is a XLR3/combo jack, which will accept a normal XLR3 male plug or a ¼" TRS phone jack. Line 4 is more sensitive than the other line (music) inputs, therefore ideal to connect wireless microphone receivers.
- 26) Mic 2 & 3 XLR inputs. To the XLR balanced input you can connect any microphone using a balanced, two wire shielded, cable. (1=earth / 2 =hot / 3=cold). For using condenser microphones see 34.
- 27) Mic 1 XLR/DIN5/Euro block input. Use only one of these parallel wired balanced inputs at the time! See wiring diagram at the back. These three inputs have been wired in parallel with the balanced jack input at the front. When you use the APart MICPAT or MICPACB paging microphones, connected directly to the DIN5 input, the signals fed into the line inputs are muted automatically while paging. The same kind of connection can be made using the euro block connector. To use "vox mute" see 28.

Phantom power: use condenser microphones see next page.

- 28) Vox mutes all. When you activate "vox mute" by turning this trimmer clockwise to the desired threshold level, the signal of any Mic1 input has priority. When you don't need "vox mute", turn this trimmer fully counter-clockwise to the "OFF" position.
- 29) Priority over music contact. By closing the contact of the euro block connector or contacts 4 and 5 of the DIN5 connector, the signal of microphone 1 only has priority over the music sources (TUNER, CD and AUX). All other microphones will remain active. The contact closure of the contacts mentioned can give priority to the other microphone inputs as well. At the same time 24 V DC will be available at terminal 20. This is very useful when using up to 4 microphones in supermarkets, etc...
- 30) Chime level. When one of the priority contacts are closed a chime can be activated by turning this trimmer clockwise to the desired chime level. When you don't need a chime, turn this control fully counter-clockwise to the "OFF" position.
- 31) Emergency / telephone input. Here you can feed the audio source for paging emergency messages, etc.. This input, at line level, has automatic activation above 200mV and has a line transformer to avoid ground loops (useful for telephone). Please use a balanced, shielded line cable. Connect the HOT signal to +, the COLD to - and the shield to G (when connecting the shield only at the MA200 side, you might avoid a ground loop, which creates hum and buzz). This signal is directly fed into the main amplifier. No microphones should be connected directly to this input without using a mic to line pre-amplifier.
- 32) Emergency / telephone level. With this potentiometer you can set the desired level of the line level signal inserted into the priority signal input 32. This level will not be influenced by the "master" level.
- 33) Airflow output. This airflow output should be kept free at all times! To give the fan a longer life time, he only starts running when the heatsink reaches a certain temperature.

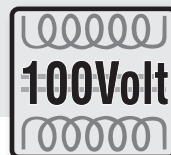

## 4. Inside Settings

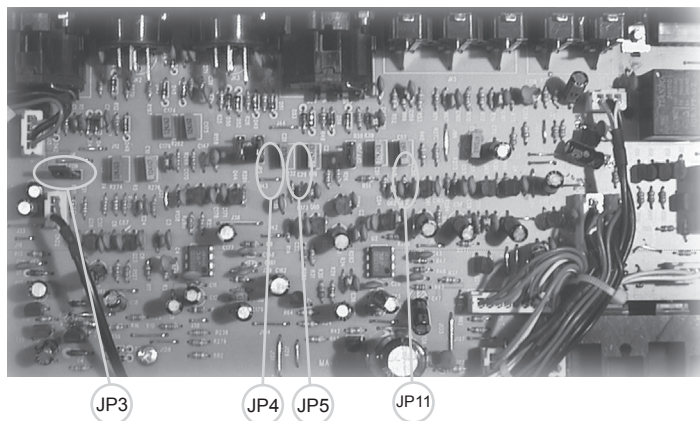

### Phantom Power

MIC1 : JP3  
 MIC2 : JP4  
 MIC3 : JP5  
 MIC4 : JP11

#### Phantom on / off jumper

The MA200 has been shipped with these jumpers in the OFF position. For each microphone input a jumper is available. When you put a jumper to the ON position, phantom power will be supplied to the microphone input involved so you can use condenser microphones. In this case NO unbalanced jacks should be used! Phantom power does not damage dynamic balanced microphones.

#### Power supply fuse (inside the housing)

When this fuse blows, replace it by the same type: 20A quick blow. When this happens frequently, contact your nearest dealer.

Now you are ready to build your solid sound system and our extra features will be of great help.

Note: In our policy of continuous improvement, changes can appear without prior notice, including the user manual.

#### Troubleshooting

**No power:** Check whether the "on/off" switch is in the on position and whether the power cord has been inserted properly. If these two have been checked and still the MA200 remains off, the fuse might be blown.

**No sound:** Check all the wires and loudspeaker selectors.

At least the master and one source should be turned clockwise.

Check whether the pre amp out is connected to the power amp in.

In the worst case your MA200 is in protective mode.

Please check your loudspeaker wiring and loads.

Operate your MA200 within normal conditions.

**Distorted sound:** Your input signal is too high.

Haven't you a line level source connected to a microphone input?

You might also be drawing too much power from your MA200 and the loudspeaker load might be too low (minimum 50 Ohm for 100V use).

Check the speaker wiring and load with an impedance tester. Turn down the master level.

**Hum and buzz:** Please check your wiring and grounding, maybe you created a ground loop.

See that all equipment linked are drawing power from the same power supply.

Your radio might get its signal from the cable radio. In this case you have created a ground loop and a ground loop isolator between the cable signal and your radio antenna input will be the solution.



## 5. Overview Of The MA200 Series



- MA200CDR**
- High quality 200 Watts 100 Volt mixing amplifier
  - Integrated AM/FM tuner and CD/MP3 player
  - 4 mic (phantom via internal switch), 4 line inputs
  - 3 level priority system, 24V priority output
  - Integrated 2-tone chime (adjustable volume)
  - 4 output zones. (Zone 4: Mic / music selection)
  - Build in dynamic limiter (-3 dB)
  - Dimensions: 88 (h) x 430 (w) x 375 (d) mm



- MA200R**
- Same as above, with AM/FM tuner only



- MA200**
- Same as above, without any music source

## 6. How To Deal With 100V Loudspeaker Systems

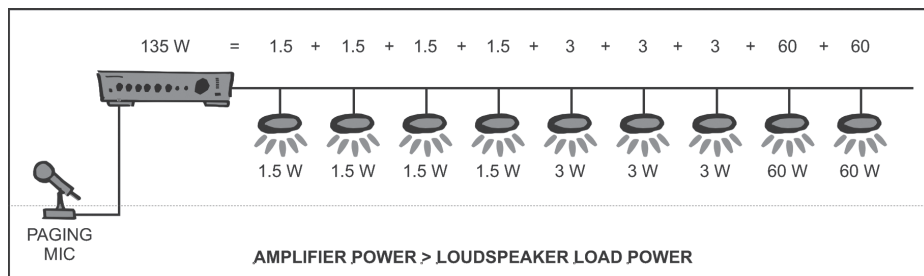

In fact working with 100V loudspeakers is rather simple, when done in the right way. Each 100V loudspeaker has a 100V transformer which can be set to a certain power, for example: 1.5 W or 6W. As the example shows, the sum of all loudspeaker settings should never exceed the amplifier's power specifications. Never use low impedance (= 8 ohm) loudspeakers on a 100V system, even not one.

More technically: When your paging amp has a maximum output of 200 watts at 100V, this means that the minimum impedance connected should be at least 50 ohm ( $100 \times 100 / 200$ ). To check your loudspeaker lines use a decent impedance checker (example AP WM100).

Now you are ready to get the best result on distributing your music and messages to your audience.

Your little giant is like a Swiss knife which will astonish you and many others!

**Find more interesting audio solutions at [www.apart-audio.com](http://www.apart-audio.com)**

## 7. MA200 Block Diagram

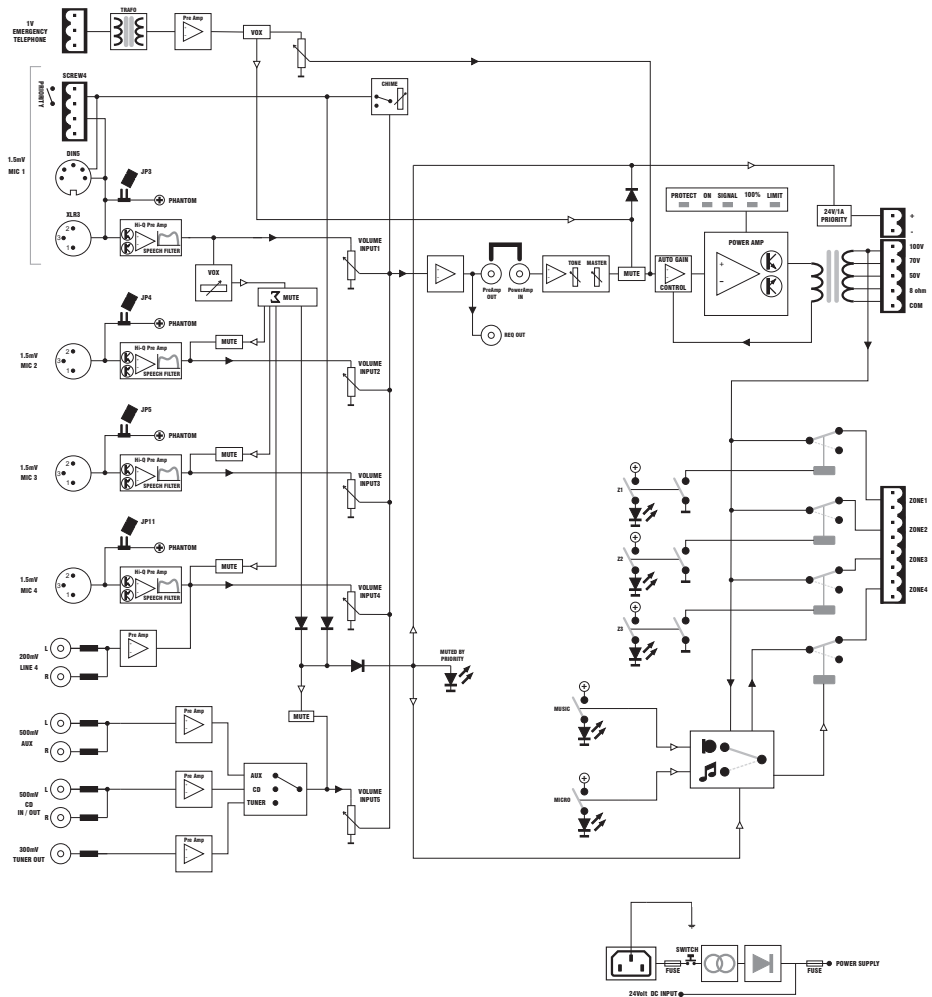

## 8. Technical Specifications

### General

FREQUENCY RESPONSE	40HZ 25KHZ (+1/-3 DB)
DISTORTION	<0,3% @ -6DB, 1KHZ
BASS CONTROL	+/- 10DB, 100 HZ
TREBLE CONTROL	+/- 10DB, 10 KHZ
S/N	amplifier: better than 95dB, 22Hz 22kHz line: better than 80dB, 22Hz 22kHz mic: better than 65dB, 22Hz 22kHz
LED INDICATORS	limiter active, red signal 100%, yellow signal -25 dB, green power on, green protection active, red
ZONE ACTIVE INDICATORS	Z1, Z2 and Z3 green LED Z4 music on/off, orange Z4 paging allowed on/off, orange
MUTED BY PRIORITY LED	any of the priority modes active, red
POWER SUPPLY	230V/ 50-60HZ MAX750VA
WEIGHT	approx.12,7 kg
DIMENSIONS	430(W) x 88(H) x 356(D)mm 19" wide, 2U high
OPERATING TEMPERATURE	-10 to +45°C



## Inputs

<b>MIC INPUT 1; 1/4" TRS PHONE JACK AT THE FRONT</b>	
<b>XLR3 COMBO, DIN5; EURO BLOCK</b>	
SENSITIVITY	1,5 mV
IMPEDANCE	600 Ω
S/N (AT MAX. VOLUME)	> 65 dB
PHANTOM POWER	14 V (internal jumper)
FREQUENCY RESPONSE	> 80Hz->15Khz (+1/-3 dB)
VOX MUTE	trigger level 0,6 mV, 1Khz, mutes mic 2,3,4+music, > 40 dB
<b>Mic input 2,3 &amp; 4: XLR3 balanced</b>	
SENSITIVITY	1,5 mV
IMPEDANCE	600 Ω
S/N (AT MAX. VOLUME)	> 65 dB
PHANTOM POWER	14 V (internal jumper)
FREQUENCY RESPONSE	> 80Hz->15Khz (+1/-3 dB)
<b>Emergency input; euro block</b>	
SENSITIVITY	1 V
IMPEDANCE	600 Ω
S/N (AT MAX. VOLUME)	> 80 dB
FREQUENCY RESPONSE	> 100Hz-> 25Khz (+1/-3 dB)
MUTE	mutes all, > 40 dB
<b>AUX INPUT; RCA</b>	
SENSITIVITY	500 mV (-6 DB)
IMPEDANCE	22 KΩ
S/N (AT MAX. VOLUME)	> 80 DB
FREQUENCY RESPONSE	> 40HZ-> 25KHZ (+1/-3 DB)
<b>LINE 4; RCA</b>	
SENSITIVITY	200 mV (-14 DB)
IMPEDANCE	47 KΩ
S/N (AT MAX. VOLUME)	> 80 DB
FREQUENCY RESPONSE	> 40HZ-> 25KHZ (+1/-3 DB)
<b>CD IN</b>	
SENSITIVITY	500 mV (-6 DB)
IMPEDANCE	5 KΩ
S/N (AT MAX. VOLUME)	> 80 DB
FREQUENCY RESPONSE	> 40HZ-> 25KHZ (+1/-3 DB)
<b>TUNER</b>	
SENSITIVITY	300 mV (-6 DB)
IMPEDANCE	30 KΩ
S/N (AT MAX. VOLUME)	> 80 DB
FREQUENCY RESPONSE	> 40HZ-> 25KHZ (+1/-3 DB)

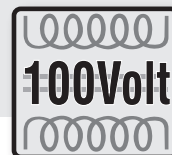

## Outputs

<b>SPEAKER SELECTOR</b>	
ZONE 1-3	on/off
ZONE 4	paging on/off music on/off
<b>SPEAKER ZONE OUTPUT, EURO BLOCK</b>	
HIGH Z ZONE 1-2-3-4	100 V
<b>SPEAKER OUT; EURO BLOCK</b>	
HIGH Z	50 (12,5 Ω) 70 (24,5 Ω) 100 V (50 Ω)
LOW Z	8 Ω
<b>PHANTOM POWER</b>	
MIC 1-2-3-4	14 V; internal jumpers
<b>PRE AMP OUT</b>	
LEVEL	1 V
<b>RECORD OUT; RCA MONO</b>	
LEVEL	1 V
<b>PRIORITY OUT</b>	
LEVEL	24 V DC; max 1A, short circuit protected
<b>CHIME</b>	
	2 tone
	activated by contact closure;
	euro block DIN5
	on/off and level set by trimmer
<b>PRIORITY</b>	
I	Emergency input / telephone
	200 mV; 1 kHz VOX threshold
	mutes all other signals
	> 40 DB
II	Vox mute only for mic 1
	0,6 mV; 1 kHz VOX threshold
	mutes mic 2,3 & 4 + music
	on/off/level set by trimmer
	> 40 dB
III	Priority contact
	> 40 dB
	mutes all music inputs



# APart

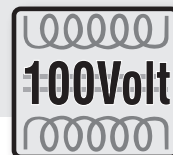

***ANY SUGGESTION?***

They are well appreciated and eventually rewarded!  
Send your ideas or suggestions to

[suggestions@apart-audio.com](mailto:suggestions@apart-audio.com)

MA200 is developed by

Audioprof nv  
Lanteernhofstraat 90  
BE-2100 Deurne  
BELGIUM



**WWW.APART-AUDIO.COM**